

# SHAPING AND SHARPENING WOODTURNING TOOLS

*ON YOUR BENCH  
GRINDER*

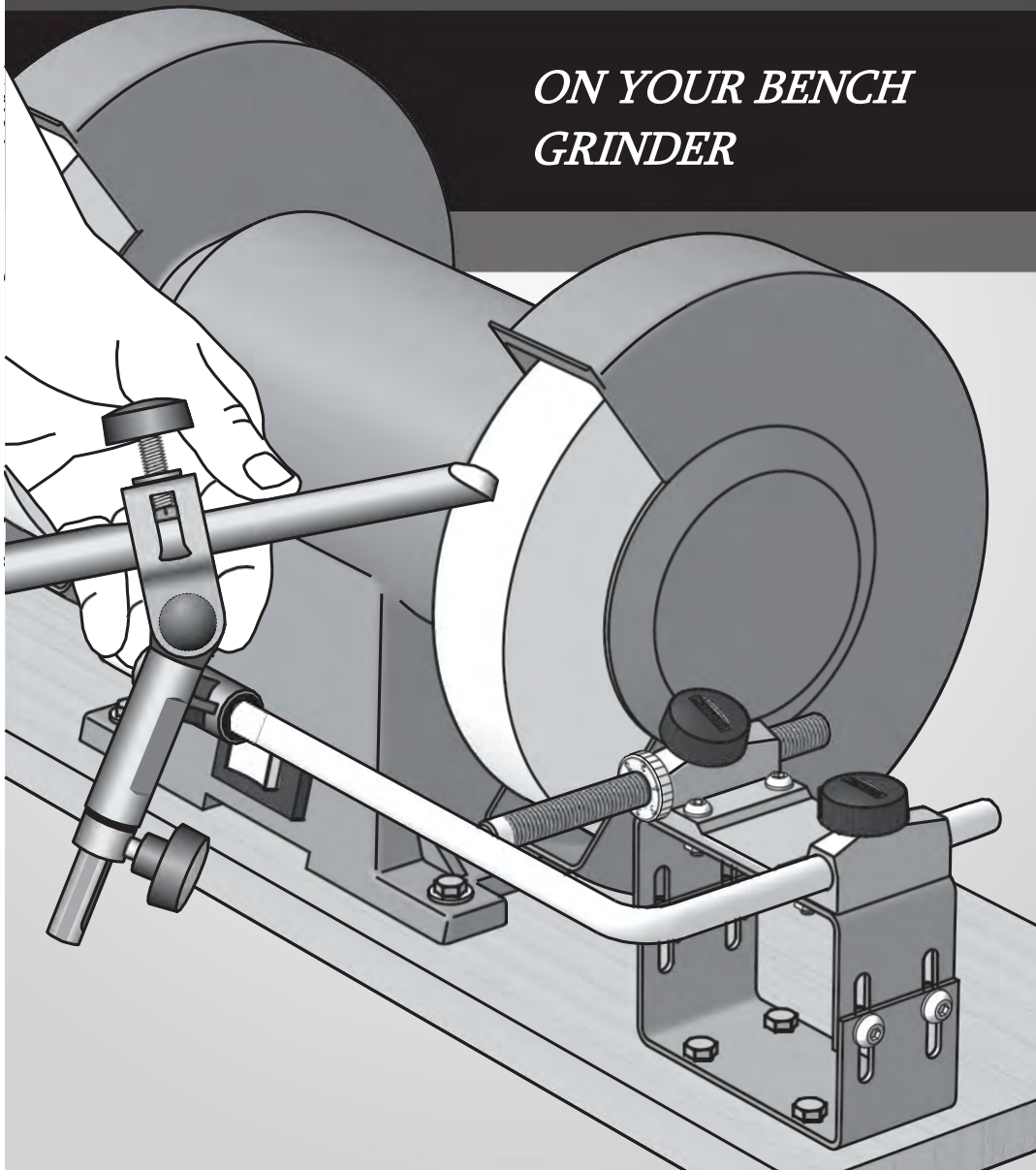

© Tormek AB 2016  
All rights reserved.

BGM-10E  
Edition 4.2

Tormek AB  
Torphyttevägen 40  
SE-711 34 Lindesberg  
Sweden

9615-1603

**WITH THE BENCH GRINDER MOUNTING SET BGM-100** you can now use the Tormek Jigs for woodturning tools and the patented Turning Tool Setter TTS-100 also on your bench grinder!

These instructions are exclusively for HSS turning tools, since dry grinding at high speed is not suitable for ordinary carbon steel tools due to the risk of overheating and its aggressive steel removal.

The Tormek method makes a distinction between shaping and sharpening. Once you have created the desired shape on the tool, it is an easy task to re-sharpen the tool exactly to the same shape every time.

After the shaping and sharpening you can go one or two steps further towards achieving the finest edge by finishing on a Tormek water cooled grinder. This is described in the handbook *Sharpening Woodturning Tools the Tormek Way*, which comes with the TNT-300 Woodturner's Instruction Box.

The handbook *Water Cooled Grinding and Sharpening of Edge Tools* covers how to sharpen all your edge tools and the whole Tormek system.

In the preparation of this handbook and the selection of the optimal shapes and edge angles, professional woodturners and woodturning educational centres around the world have been of great help. We would like to thank you all for your experienced advice.

Good luck with your sharpening!

*Torgny Jansson  
and the Tormek team*



## Contents

Mounting the BGM-100 Set on Your Grinder .....	6
About Bench Grinders .....	9
Safety .....	10
Tormek Accessories for Your Bench Grinder .....	12
Turning Tool Setter TTS-100 .....	13
Gouge Jig SVD-186 (SVD-185).....	16
Multi Jig SVS-50 .....	18
Tool Rest SVD-110 .....	20
Sharpening Bowl and Spindle Gouges .....	21
Sharpening Exchangeable Cutters .....	27
Sharpening Skew Chisels.....	29
Sharpening Roughing Gouges .....	32
Parting, Beading and Bedan Tools.....	33
Sharpening Scrapers.....	34
Sharpening Thin and Flat Parting Tools.....	36
Sharpening Elliptical Spindle Tools.....	36

## Mounting the BGM-100 Set on Your Grinder

The Bench Grinder Mounting Set BGM-100 can be mounted on grinders with wheel diameters from 150 mm (6") to 250 mm (10"). You can either mount the grinder and the BGM-100 on a self made wooden platform or you can mount the grinder and the BGM-100 directly on the bench.

You can mount the BGM-100 set on the left or on the right side of the grinder whichever suits you best. On some grinders, you need to remove the tool rest which comes with the machine, in order to mount the Tormek Universal Support. You can also mount a set on both sides, which gives you a versatile sharpening station.

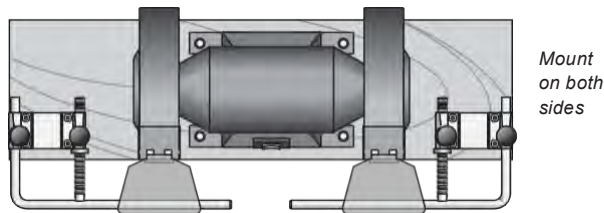
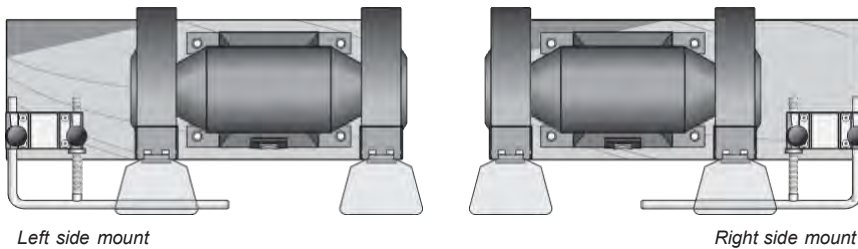

### Mounting on a Wolverine v-arm

If you already have a Wolverine v-arm mounted by your grinder, you can complement it with the *Tormek OWC-1 Converter* and adapt the Tormek Bench Grinder Mounting Kit BGM-100 directly to the v-arm.

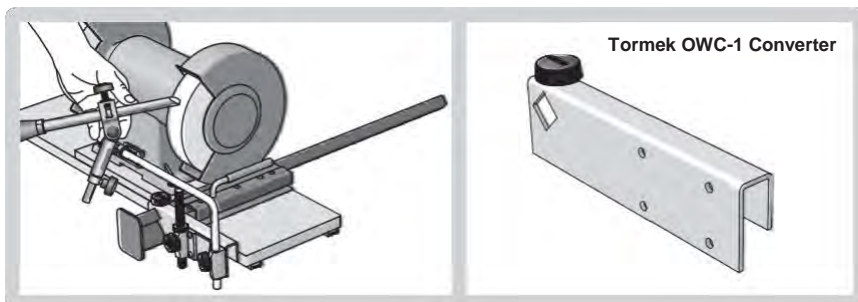

The **Tormek OWC-1 Converter** is sold separately, ask your dealer for more information.

*(Wolverine is a product manufactured by OneWay Manufacturing. Tormek is not affiliated with OneWay in any way. The Wolverine and OneWay trademarks are the property of their respective owners.)*

**Contents: Bench Grinder Mounting Set BGM-100**

- Universal Support with Micro Adjust 1 pc
- Base for the Universal Support 1 pc
- Height adjustable block 56–89 mm (2<sup>3</sup>/<sub>16</sub>–3<sup>1</sup>/<sub>2</sub>") 1 set
- Rubber feet 4 pcs
- BGM-10 Handbook 1 pc
- Pro/le Labels 1 set
- Bolt M6×12 with nut and washer 4 pcs
- Bolt M5×16 with nut and washer 4 pcs
- Bolt M6×40 with nut and washer 4 pcs

**Making the platform**

Use wood or plywood with a minimum thickness of 20 mm (¾"). The dimensions depend upon your grinder, see sketches below.

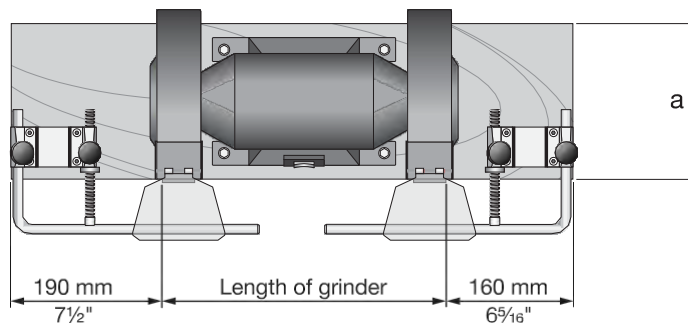

**Dimensions**

Grinder size	a	b
150 mm (6")	200 mm (8")	10 mm (¾")
200 mm (8")	200 mm (8")	35 mm (1½")
250 mm (10")	250 mm (10")	60 mm (2½")

**Length of platform**

This depends on your grinder and if you use one or two BGM-100 sets. The recommended lengths on the left and on the right side differ due to the asymmetrical Gouge Jig SVD-186.

**Height of block**

The optimal height of the block depends on the design of your grinder. The best way to make sure the jigs and tools don't hit the guards on your machine is by using the Turning Tool Setter TTS-100 when setting the height. If your grinder needs a block higher than 89 mm (3½") place the adjustable block on a piece of wood.

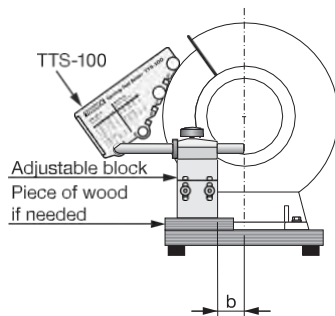

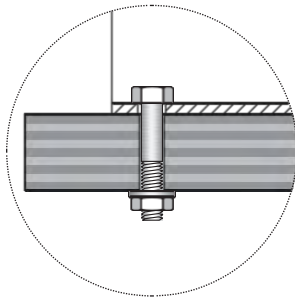
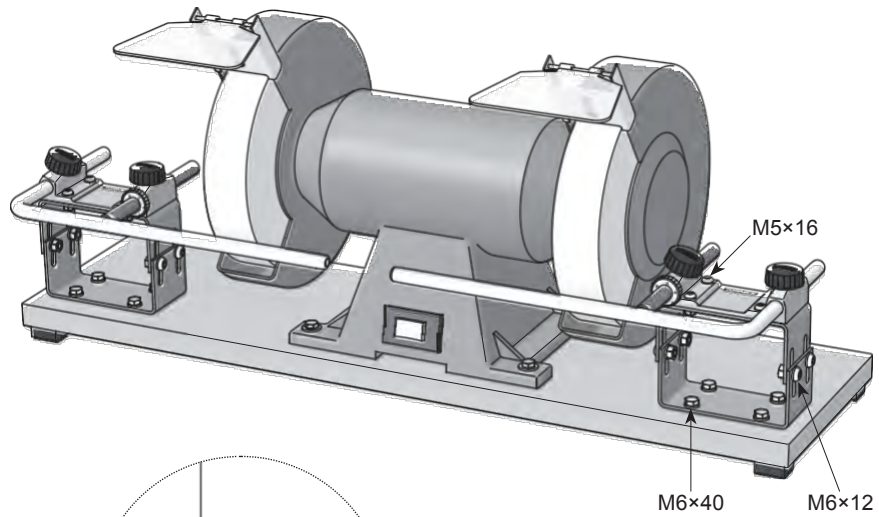

Bolt the block to the platform.

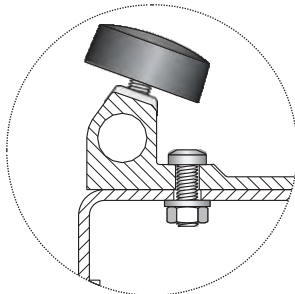

Bolt the base for the Universal Support to the block.

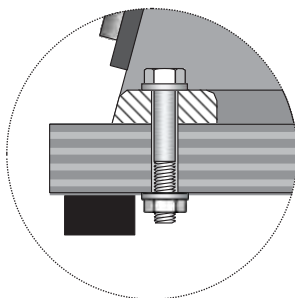

Mount the grinder with suitable bolts, which fit the holes in the grinder. Use washers under the bolt heads and nuts.

Mount the rubber feet and you will get a steady platform with less vibration.



## About Bench Grinders

### Using the right type of grinding wheel

Not all grinding wheels are suitable for the precision sharpening of edge tools. The standard wheels mounted on the grinder are often too hard and become glazed easily, which reduces steel removal and causes overheating of the tool. Use an aluminium oxide wheel with the right binding – not too hard to avoid glazing and not too soft to avoid grooves.

### Wheel surface

The wheel surface must be kept fresh and clean. Worn grains must wear away so that new ones come into play. If not, the surface becomes glazed and the grains will rub instead of cutting, which will increase the friction and heat development. Use a diamond wheel dresser to maintain the surface in a good shape and condition.

### Influence of heat on HSS steel

HSS steel can stand a much higher temperature than carbon steel without decreasing the hardness. However, at the very tip of the edge which is very thin, the temperature can easily rise to a level which will affect the hardness. Therefore grind cautiously at the tip of the edge and do not allow it to become blue. Overheating HSS steel can cause a decrease in the hardness by as much as 4 HRC, which shortens the life of the edge. If you cool it in water, do not cool abruptly from a high temperature, since this can cause micro cracks invisible to the naked eye.

### Grinding dust

The fine dust from the grinding wheel and steel particles from the tool can be a health hazard. It is best to use a dust extraction system, so the dust does not pollute the air. You must use a separate extraction system and not the same system as for your wood dust, since a spark could light a fire in the inflammable fine dust.

## Safety

A bench grinder can be dangerous if not handled with knowledge and respect. Follow the safety instructions, which come with your machine. Pay special attention to the following operational advice.

- Wear eye protection.
- Do not work near dry shavings or wood dust, since a spark can light a fire.
- Secure the platform on your bench to ensure that the grinder does not move during operation. Use screws or a clamp.
- Use only the Tormek accessories shown in this presentation on your bench grinder. Follow this instruction manual.
- Check that all setting screws and knobs are properly tightened before commencing work.
- Do not hold your hand or fingers close to the wheel to avoid the risk that they might slip and touch the wheel.
- Do not press the tool harder against the wheel than that which enables you to keep full control of the grinding operation.
- Always keep a part of the tool on the wheel during grinding and never let it slip wholly outside the wheel.

### Using the Multi Jig SVS-50

Always let the jig rest on the Universal Support steadily before you carefully lower the tip of the tool to touch the wheel. Maintain pressure all the time towards the Universal Support.

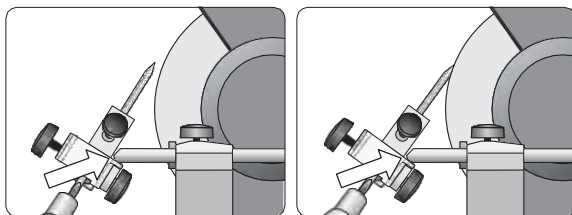

**Using the Tool Rest SVD-110**

The platform must always be mounted so the surface points to or above the centre of the wheel. The distance between the platform and the wheel must not exceed 2 mm (3/32").

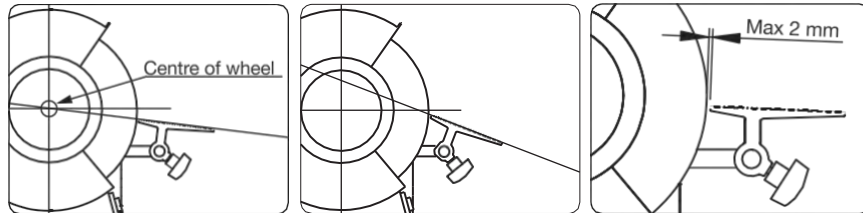

**Using the Universal Support as tool rest**

The distance between the Universal Support and the wheel must not exceed 2 mm (3/32").

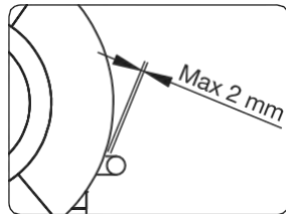

## Tormek Accessories for Your Bench Grinder

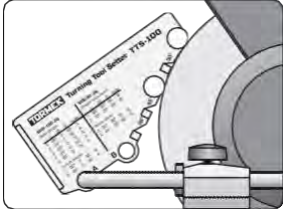

### Turning Tool Setter TTS-100

For setting the Gouge Jig SVD-186 and the Multi Jig SVS-50.

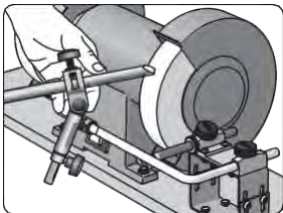

### Gouge Jig SVD-186

For bowl gouges, spindle gouges and elliptical spindle gouges. Also for cutter/scrapper tips.

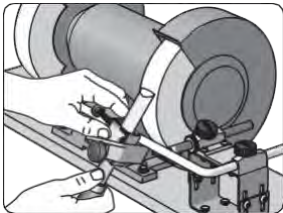

### Multi Jig SVS-50

For skews with a straight or curved edge, roughing gouges, diamond section parting tools, beading tools and bedan tools.

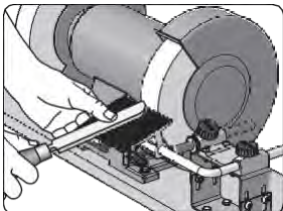

### Tool Rest SVD-110

For scrapers, thin and flat parting tools, hollowing tools and large cutters.

## Turning Tool Setter TTS-100

No matter if you sharpen on a bench grinder or on a grindstone, the most difficult part in sharpening woodturning tools is to replicate the shape and the edge angle. Tormek have solved this problem by developing a key to instant and exact sharpening – the Turning Tool Setter.

This setting device takes the guesswork out of sharpening. There is no longer any need for trial and error to get the best edge shape for each turning operation. You just set the jig and get the shape you have selected. Thanks to the patented design it works irrespectively of the stone diameter. You can go from a 150 mm (6") wheel to a 250 mm (10") grindstone and achieve the same shape. The Setter is designed to work in conjunction with the *Gouge Jig SVD-186* and the *Multi Jig SVS-50*.

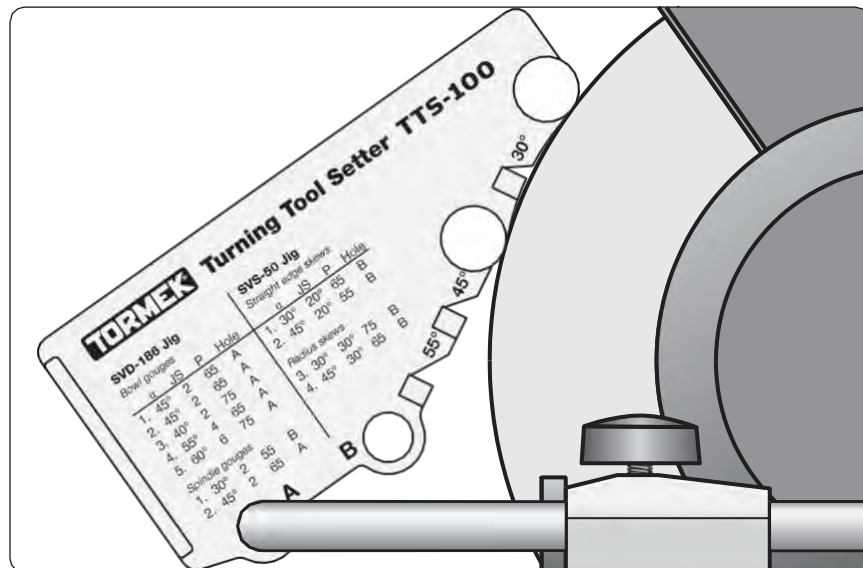

### What determines the shape?

Three factors determine the shape of a gouge or a skew. By repeating them at each shaping or sharpening you will get an exact replication of the shape every time.

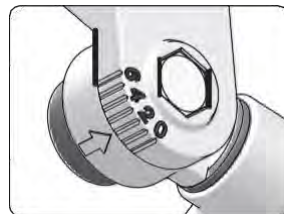

JIG SETTING = JS

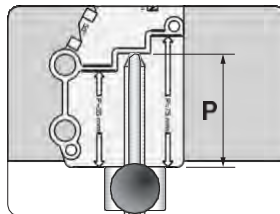

PROTRUSION = P

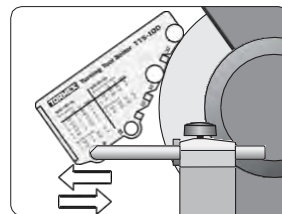

DISTANCE TO STONE

### **Shaping and sharpening**

The Tormek method makes a distinction between the shaping and sharpening (or re-sharpening) of a tool. When shaping you remove steel to achieve the shape and edge angle you want. When sharpening you just touch up an existing shape to renew the sharpness. Generally you often say grinding for both shaping and sharpening.

If you have a Tormek machine, you can create the initial shape on your bench grinder and finish the sharpening on your Tormek water cooled grindstone. You get the best of two worlds; the fast steel removal from your high speed bench grinder and the fine surface from your fine water cooled grindstone and the leather honing wheel. A finer edge gives the wood a smoother finish with less need for sanding. A finer edge also cuts easier than a rough edge and stays sharp longer before it needs re-sharpening.

### **Selected shapes and edge angles**

There are quite a few manufacturers of turning tools and the shapes and edge angles vary considerably. For example there are factory made skew chisels with skew angles from 15° to 30° and the edge angles vary from 25° to 40°. Factory made bowl gouges have edge angles from 30° to 60°. The wide range of shapes is the reason why Tormek up until now, has not made recommendations for setting the shape and edge angle. In the past, we have offered the technique and left each turner to find his or her own geometry.

However, after having been in contact with many turners around the world, we now see the need for an aid to the quick setting of the jig and also for advice about some suitable shapes and edge angles. This newly developed Tormek Turning Tool Setter TTS-100 offers both. The geometries, i.e. the shape and edge angle have been selected after consulting experienced turners and should satisfy most needs.

### **Which shape should I use?**

The Turning Tool Setter is delivered with a Selection Chart (pages 21 and 29) where you can see which shape is suitable for your current type of turning. These geometries are recommended by experienced woodturners and recognized woodturning training workshops around the world.

Of course you can also sharpen with geometries other than the shapes provided by the TTS-100 Setter. If you have an existing edge geometry you can use the Marker Method or the Spacer Block Method for setting the edge angle at the re-sharpening (page 26).

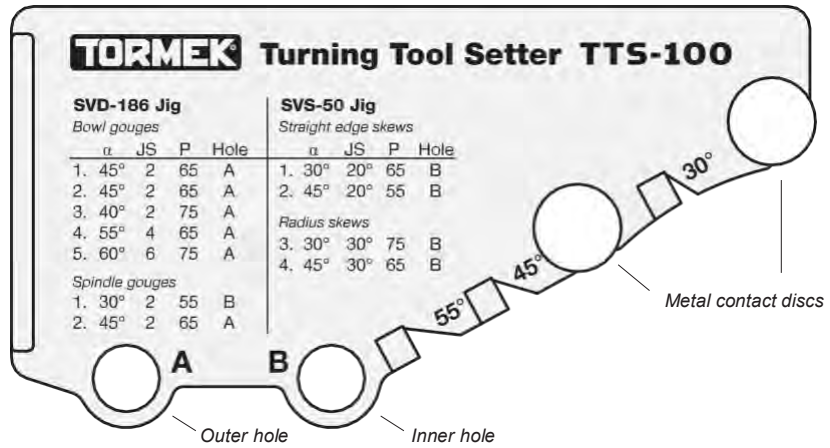

**Side 1**

There are two holes for the Universal Support, A and B.  
The type of tool and profile you require decide which hole to use.

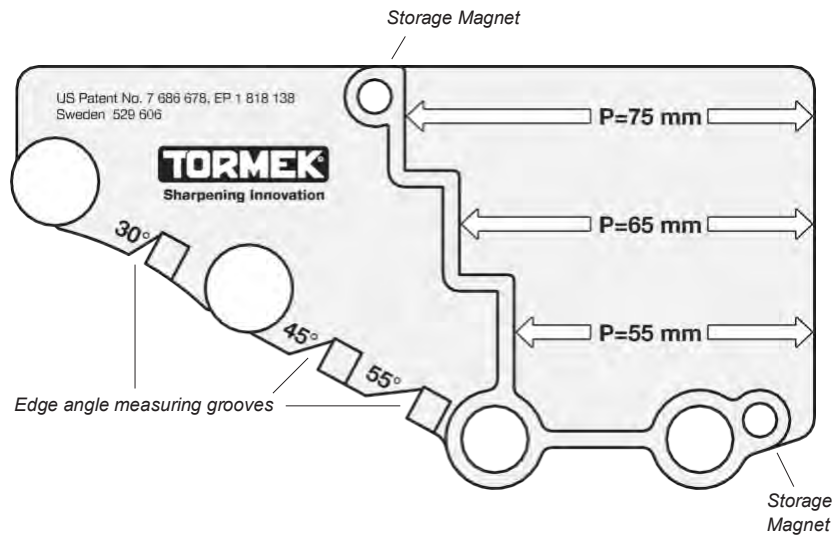

**Side 2**

This side has stops for the recommended protrusions of the tool in the jig (P).

## Gouge Jig SVD-186 (SVD-185)

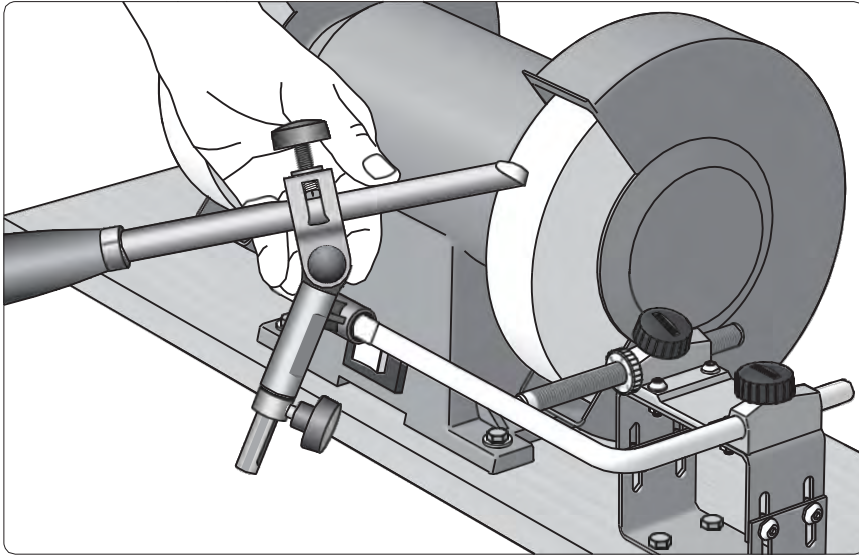

The jig works on the Universal Support. The edge angle is set by moving the support back and forth. The Micro Adjust facilitates a precise setting.

SVD-186 is a further development of SVD-185.

SVD-186 now fits up to 36 (1 1/2") mm wide tools (2), has an improved disc (1) and an easy and precise click setting (3).

The lower sleeve (4) has been shortened in order to work better with the Tormek T-3 and T-4.

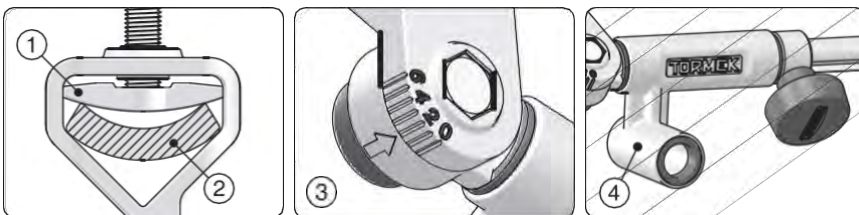



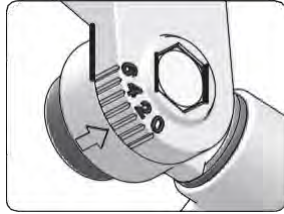

The tool holder can be set in any position from 0 to 6.

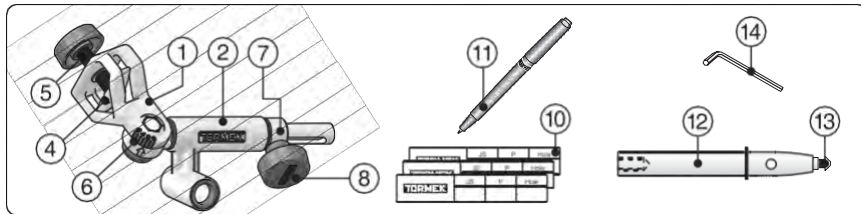

**Parts**

The jig comprises a tool holder (1) which runs in a sleeve (2). The tool is aligned with a disc (4) and tightened with a knob screw (5). There is a washer (6) for wide gouges. The stop ring (7) can be set for a convex bevel with a screw (8). The setting can be noted on a special proFile label (10), which is attached to the ferrule. A special pen which works on these labels, is included (11). For cutter/scrapper tips there is a shaft (12) with a mounting screw (13) and a 2,5 mm allen key (14).

## Multi Jig SVS-50

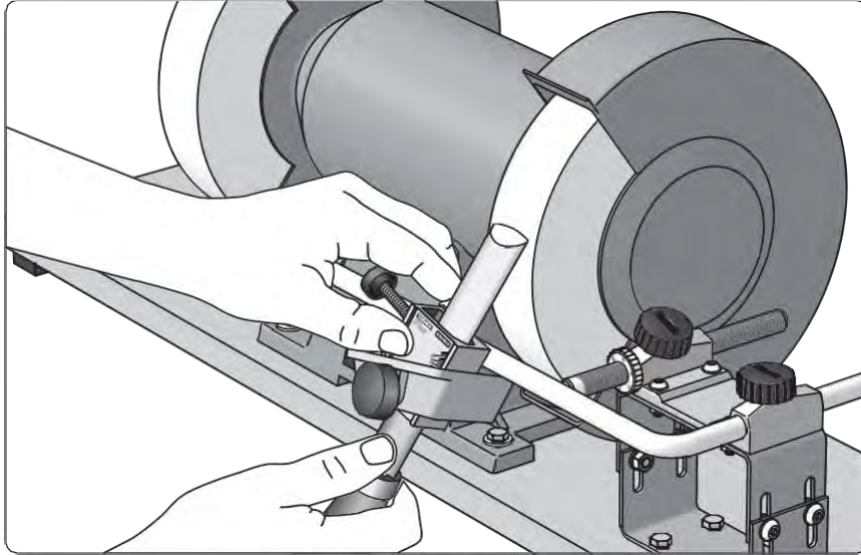

The jig works on the Universal Support. The edge angle is set by moving the support back and forth. The Micro Adjust facilitates a precise setting.

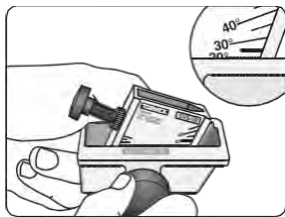

*The seat can be set straight or to any skew angle from 0° to 45°.*

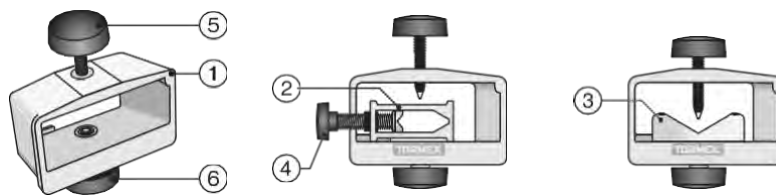

### Parts

This patented jig consists of a housing (1) and two interchangeable seats – one closed, (2) and one open, (3). The seats can swivel and be locked with the screw (6) at any skew angle between 0° and 45°. Skew chisels should have symmetrical bevels on both sides. With this jig you mount the tool only once for grinding both the bevels. By turning the jig upside down you can grind both of the bevels symmetrically.

### Closed seat

The closed seat has been developed for the precision sharpening of turning skew chisels with an oval or square section and with curved or straight edges. Since the chisel is mounted in the centre of the seat, the bevels are ground to exactly the same shape. The turning skew chisel is mounted with a side screw (4). Max tool width 35 mm (1 3/8").

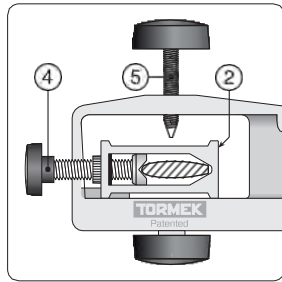

*The closed seat (2) is for skew chisels. The tool is fixed with the side screw (4). The top screw (5) is not used.*

### Open seat

The open seat, where the tool is fixed with a top screw (5), is used for tools which have the edge ground square across the shank, such as parting tools with a diamond section, bedan tools and roughing gouges. Both seats are mounted with a bottom screw (6), which also locks the chosen skew angle. A scale on each seat shows the skew angle.

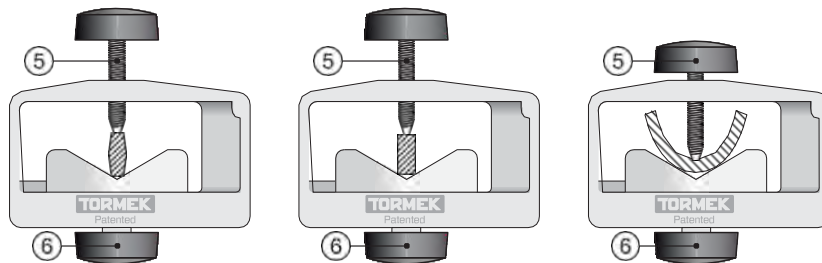

*The open seat is designed for tools which have the edge square across the shank. The tool is fixed with the top screw in the housing (5).*

## Tool Rest SVD-110

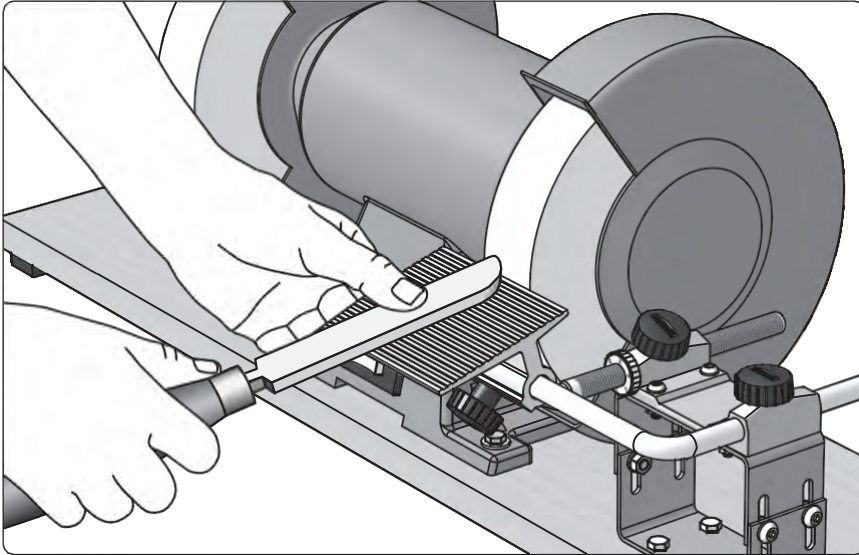

The Tool Rest works on the Universal Support. The edge angle is set by rotating the Tool Rest on the support. It has a generous surface, 90×110 mm (3½"×4¼"), which permits a safe and steady positioning of the tool towards the stone.

The bore is made with a special wedge shape, which increases the locking force by as much as 250%. You can lock the Tool Rest instantly at the chosen angle. This unique design is patented by Tormek.

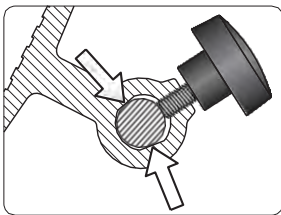

*With the patented design, only the sides of the tapered bore touch the round bar – not the bottom. This means that the locking action increases by as much as 250 %!*

## Sharpening Bowl and Spindle Gouges

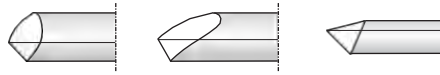

These are ground with the Gouge Jig SVD-186. Bowl and spindle gouges can have an unlimited number of shapes. The variables are the edge angle ( $\alpha$ ) and the lengths of the wings ( $l$ ). The third factor is how the wings are shaped. They can be straight or convex.

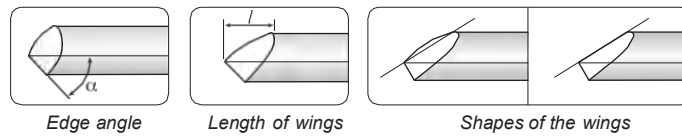

The chart below shows suitable shapes, which have been recommended by experienced woodturners and recognized woodturning workshops. Decide which shape you want. Once you have created the desired shape on the tool, it is an easy task to re-sharpen it to exactly the same shape every time.

<i>Bowl gouges</i>				
1	$\alpha=45^\circ$		JS 2 P 65 Hole A	Standard profile. Only lightly swept back wings. For turners of all skill levels.
2	$\alpha=45^\circ$			Irish profile. Swept back wings. Swing the tool $180^\circ$ from side to side.
3	$\alpha=40^\circ$		JS 2 P 75 Hole A	With long swept back wings. Somewhat aggressive. For professional level turners.
4	$\alpha=55^\circ$		JS 4 P 65 Hole A	The larger edge angle is beneficial when turning deep bowls.
5	$\alpha=60^\circ$		JS 6 P 75 Hole A	"Ellsworth" shape. Wings are pronounced convex.

<i>Spindle gouges</i>				
1	$\alpha=30^\circ$		JS 2 P 55 Hole B	For tight spots, detail work and finest finish. For professional level turners.
2	$\alpha=45^\circ$		JS 2 P 65 Hole A	Standard profile. For turners of all skill levels.

## Shaping

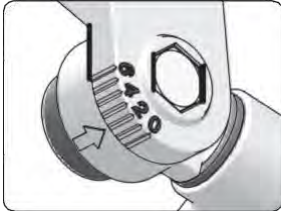

Set the Jig, JS.

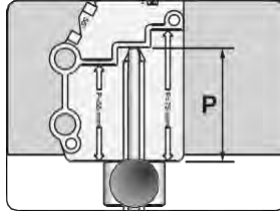

Mount the tool with the protrusion P.

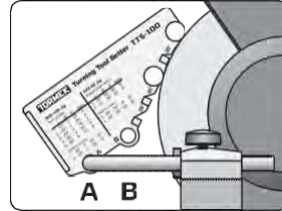

Set the Universal Support. Select hole A or B.

Select a shape from the selection chart and make the three settings which will give you that shape. Grind with a light pressure so that you do not overheat the steel. Use the whole width of the wheel to minimize grooving and to prolong the wheel life. Check your grinding frequently to ensure that the gouge is ground evenly and acquires the shape you want. Grind more on the spots where needed. If you need to change the profile considerably, grind one side at a time. This is easier than continuously swinging the tool back and forth from left to right, and which could cause you to overgrind the centre of the edge.

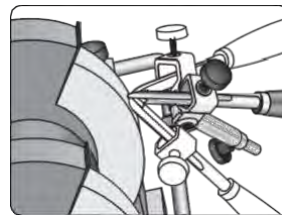
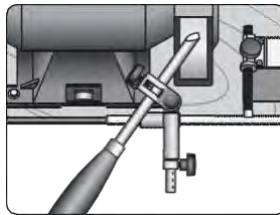
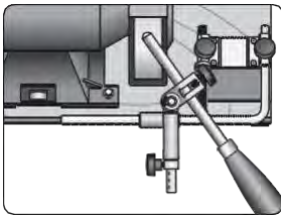

Shape one side at a time and use the whole width of the wheel. Finish with a full swing over the entire bevel.

**Note** Stick to the shape you have selected and do not switch from one shape to another. Then you will get the full benefit of the Tormek TTS-100 Setter, since you can instantly replicate exactly the same shape every time. Should you need a different shape, we suggest that you buy another tool and grind it to your alternative shape. This way of working will give you more time for turning and fewer interruptions for shaping and sharpening.

### Shape and length of the wings

The three settings do not automatically give you the shape you have selected. Your hands and eyes decide the final shape within the limits of the three settings. You can acquire different lengths on the wings by altering the width of your swing from side to side. A common problem is that the tip can be too pronounced. This is caused by grinding too much on the wings. The cure is to grind more on the tip until you achieve the right shape.

**Length of the wings**

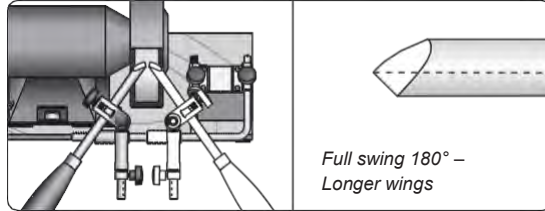

The width of the jig swing determines the length of the wings.

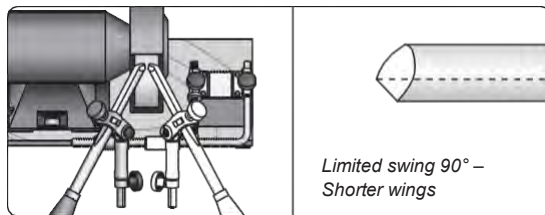

**Shape of the wings**

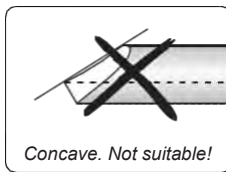
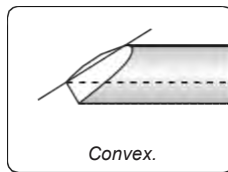

Grind so the wings become symmetrical and slightly convex or straight. They must never be concave.

**Note** You decide how much grinding takes place on any one spot and hence the final shape. If the wings tend to be concave, then grind more on the centre of the edge.

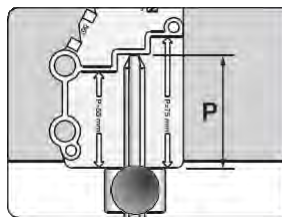

Check that the protrusion has not decreased during the shaping caused by that steel has been ground away from the tip. If so, re-position the tool to the correct protrusion and then make the final shaping. By doing so, you will ensure that you exactly replicate the edge geometry at future sharpenings.

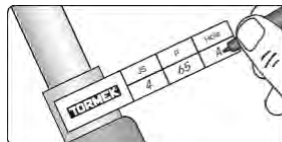

Note the three settings on the Profile Label and put it on the ferrule. Now you have the recipe of the shape and you can exactly replicate it at each future re-sharpenings.

### Rounding off the heel

You can round off the heel of the bevel by moving the Universal Support towards the grinding wheel. Lock it properly.

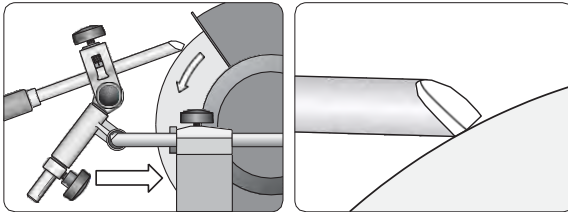

**Important** Do not use the built in feature for moving the stop ring!  
This is used only for the Tormek water cooled grinder, where the stone rotates away from the edge.

### Re-sharpening

Follow the settings that you have noted on the Profile Label and you will obtain exactly the same shape every time, even when the stone wears and decreases in diameter.

<b>TORMEK</b>	JS	P	Hole
	4	65	A

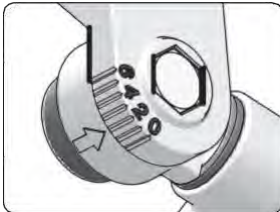

Set the jig with the same jig setting, JS.

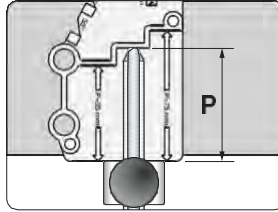

Mount the tool with the same protrusion, P.

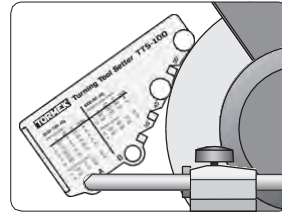

Set the Universal Support using the same hole, A or B.

### Honing





If you don't do the final sharpening on a Tormek water cooled grinder, then remove the burr and refine the edge with a honing stone.hone the flute with a slip stone. A finer edge cuts more cleanly, leaves a finer surface on the wood and stays sharp longer.

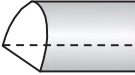
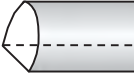
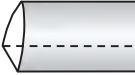
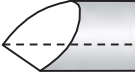
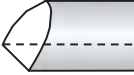
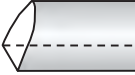
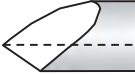
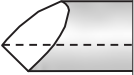
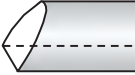
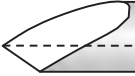
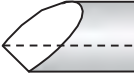
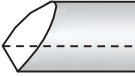
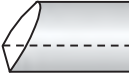
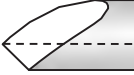
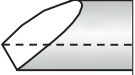
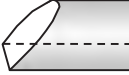

**Other shapes**

You can of course shape your gouge to a different geometry from those provided with the TTS-100 Setter. This graph shows examples of shapes which you can achieve on a bowl gouge at various jig settings and at various edge angles. The protrusion of the tool in the jig P is 65 mm. The gouge is swung fully 180° from side to side. The edge angles are approximate.

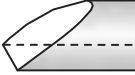
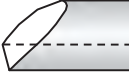
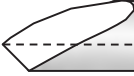
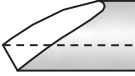
For these geometries you use the Marker Method or the Spacer Block Method at the re-sharpening. For the TTS-100 shapes JS2/45° and JS4/55° you use the TTS-100 method.

Jig Setting	Edge angle 35°	Edge angle 45°	Edge angle 55°	Edge angle 75°
<b>JS 0</b>				
<b>JS 1</b>				
<b>JS 2</b>				
<b>JS 3</b>				
<b>JS 4</b>				
<b>JS 5</b>				
<b>JS 6</b>				

*\*The shapes JS2/45° and JS4/55° can be obtained with the TTS-100 Setter.*

### Replicating a non TTS-100 shape

For shapes different from those obtained with the TTS-100 setter, you can use one of these methods to set the Universal Support and replicate the edge angle. Note the jig setting JS and the protrusion P on the profile label.

#### 1. The Marker Method

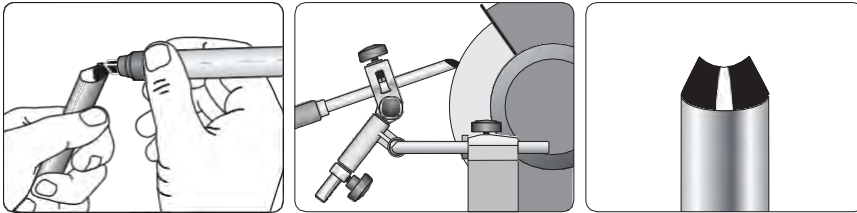

Colour the bevel with a marker. Turn the wheel by hand and adjust the Universal Support until the colouring is removed from the tip to the heel.

#### 2. The Spacer Block Method

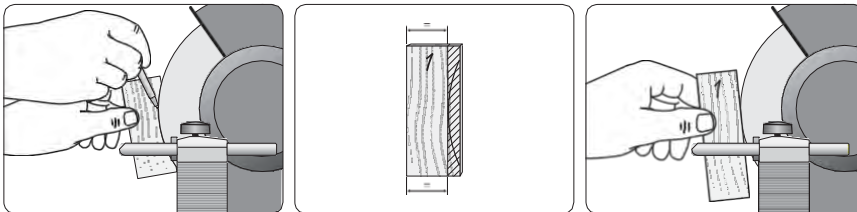

This method requires a constant stone diameter to give an exact replication. Place a rectangular wooden block close to the wheel and mark the contour. Draw a parallel line and cut away the surplus wood. Now you have a wooden spacer, which lets you copy the setting of the Universal Support.

**Note** The Marker Method is always exact, but is not as fast as the Spacer Block Method. The Spacer Block Method is exact only as long as the wheel diameter remains constant.

## Sharpening Exchangeable Cutters



These are sharpened in the SVD-186 jig. There are various types and sizes of exchangeable cutters for hollowing and scraping. The holes vary from 4–8 mm (5/32–5/16"), but due to a shoulder on the shaft they can all be mounted with the same screw. The cutters can be sharpened to their existing shape or to a new shape.

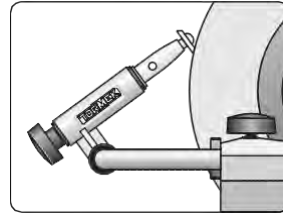

### Mounting the jig

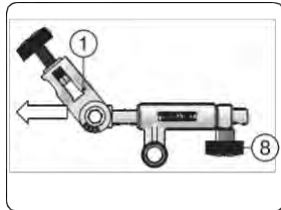

Loosen and remove the screw (8) and the tool holder (1).

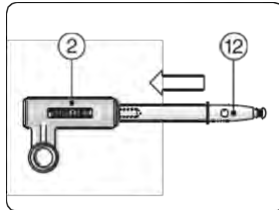

Insert the shaft (12) into the sleeve (2). Note: Position the sleeve according to the picture!

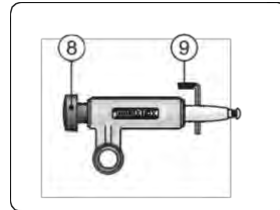

Mount the screw (8). Lock the shaft with the Allen key (9) when tightening.

### Mounting the cutter

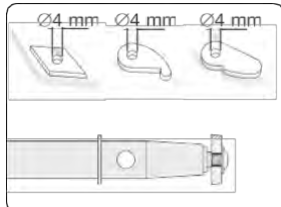

Cutters with 4 mm (5/32") holes are centered by the M4 screw.

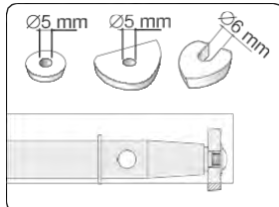

Cutters with 5 and 6 mm (3/16"–1/4") holes are centered on the first shoulder on the shaft.

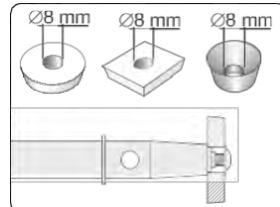

Cutters with 8 mm (5/16") holes are centered on the second shoulder on the shaft.

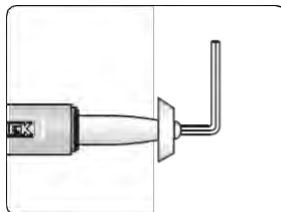

Use the Allen key (14), which comes with the jig.

### Setting the edge angle

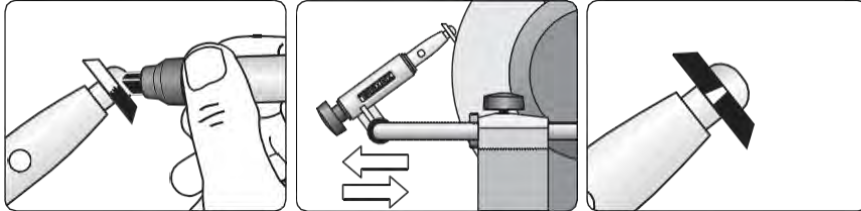

Use the Marker Method for the first sharpening. Set the Universal Support so that the grinding wheel touches the entire width of the bevel whilst rotating it by hand. At the correct setting, the wheel removes the colouring along the whole width of the bevel.

### Sharpening

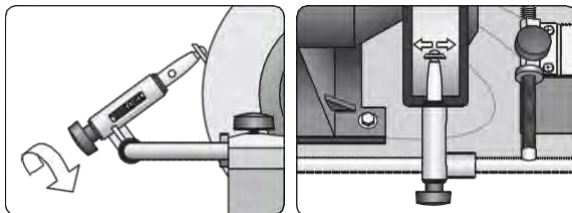

Rotate the jig during the sharpening so you achieve an even grinding around the whole circumference. Slide the jig sideways on the Universal Support so the grinding wheel wears evenly. Use a light pressure for the best result.

## Sharpening Skew Chisels

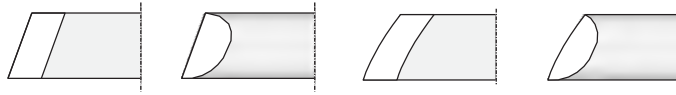

These are sharpened in the Multi Jig SVS-50 with the closed seat. There are many shapes of skews since the section, skew angle and edge angle can all vary. A fourth dimension can be added if you shape the edge to a convex curve.

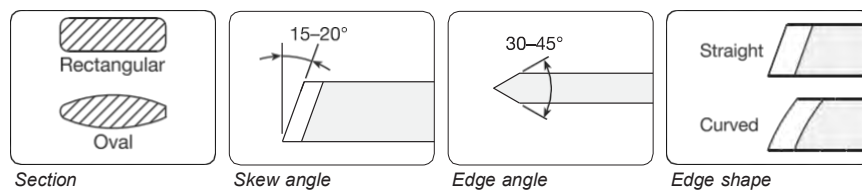

The chart below shows suitable shapes, which have been recommended by experienced woodturners and recognized woodturning workshops. Decide which shape you want. Once you have created the desired shape on the tool, it is an easy task to re-sharpen it to exactly the same shape every time.

Skews			
1	Straight edges $\alpha=30^\circ$ Flat Oval	<b>JS</b> 20° <b>P</b> 65 <b>Hole</b> B	For tight spots, detail work and finest finish. For professional level turners.
2	Straight edges $\alpha=45^\circ$ Flat Oval	<b>JS</b> 20° <b>P</b> 55 <b>Hole</b> B	For broad application. Easier to control than a 30° edge angle.
3	Radius edges $\alpha=30^\circ$ Flat Oval	<b>JS</b> 30° <b>P</b> 75 <b>Hole</b> B	For tight spots, detail work and finest finish. For professional level turners.
4	Radius edges $\alpha=45^\circ$ Flat Oval	<b>JS</b> 30° <b>P</b> 65 <b>Hole</b> B	For broad application. Easier to control than a 30° edge angle.

## Shaping



Select a shape from the selection chart. Then set the jig, JS.

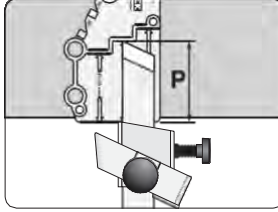

Mount the tool with the protrusion, P.

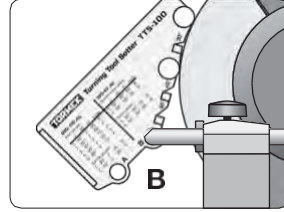

Set the Universal Support. Use hole B.

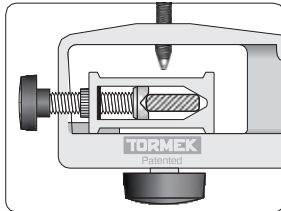

Check that the tool is correctly aligned so that the shape will be exactly replicated when re-sharpening.

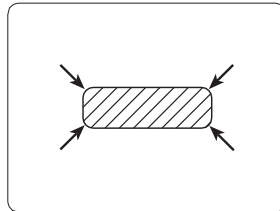

If your skew has sharp corners, you should round them off before mounting the tool. This will help ensure a correct alignment.

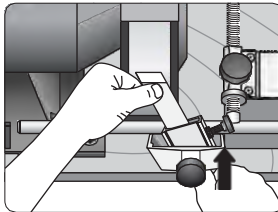
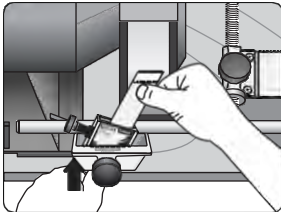

Grind with a light pressure so you do not overheat the steel.

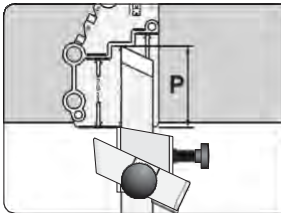

Check that the protrusion has not decreased during the shaping. If so, re-position the tool to the correct protrusion and then make the final shaping. By doing so, you will ensure that you exactly replicate the edge geometry in the future.

### Oval section

Thanks to the patented design of the SVS-50 jig it is just as easy to shape an oval skew as an ordinary skew with a rectangular section. The wide base of the seat ensures an accurate alignment and a steady running on the Universal Support.

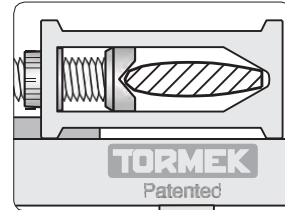

### Curved edge

You can shape the edge so it becomes convex by pivoting the jig on its bevelled corner, A. To achieve a suitable curve you set the jig with a larger skew angle. For a skew with a 20° skew angle, you set the jig on JS=30°. Now grind only the low point so the curve meets the long point as a tangent.

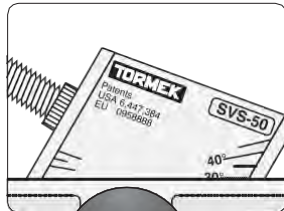

Set the jig on 30°.

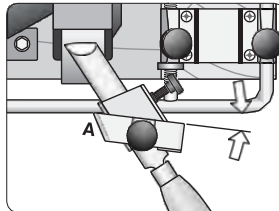

Pivot the jig on the bevelled corner A. Grind the low point only. The seat must all the time rest on the Universal Support.

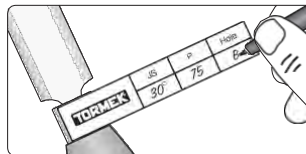
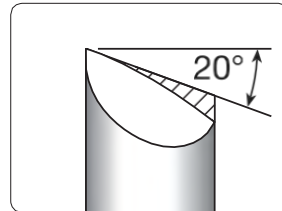

Note the three settings on the Profile Label and put it on the ferrule. Now you have the recipe for the shape and you can exactly replicate it at each future re-sharpenings.

### Re-sharpening

Make the three settings noted on the Profile Label carefully and you will obtain exactly the same shape every time even when the stone wears and decreases in diameter.

### Honing

If you do not do the final sharpening on a Tormek water cooled grinder, then remove the burr and refine the edge with a honing stone. Hone the flute with a slip stone. A honed edge cuts more cleanly, leaves a finer surface on the wood and stays sharp longer.

### Other shapes

You can of course shape your skew to a geometry different from those provided with the TTS-100 setter. Set the jig to the existing skew angle or to a new angle of your choice. (from 0° to 45°). Note the skew angle JS and the protrusion P on the profile label so you can replicate the shape. To set the Universal Support for replicating the edge angle, you use either the Marker Method or the Spacer Block Method. This is explained for gouges on page 26.

## Sharpening Roughing Gouges

The Multi Jig SVS-50 with the open seat is used



### Settings

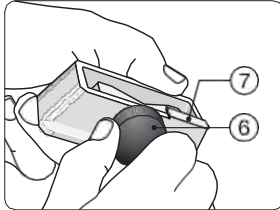

Lock the seat with the bottom screw (6) in the straight position (0°). The seat should touch the stop (7).

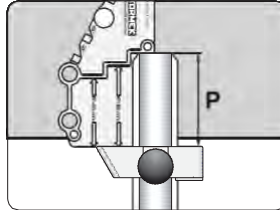

Mount the gouge protruding (P) 75 mm and lock it with the top screw (5).

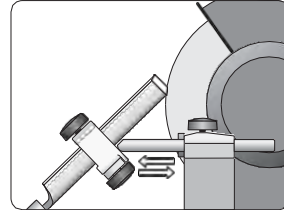

Set the edge angle by adjusting the Universal Support. Use the Marker Method.

When re-sharpening an existing edge angle, use the Marker Method or the Spacer Block Method (page 26).

### Sharpening

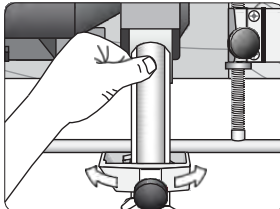

Roll the gouge on the Universal Support. Slide the jig sideways so that the wheel wears evenly.

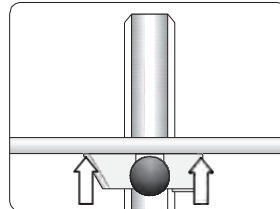

Ensure that the entire flange of the jig is in contact with the Universal Support.

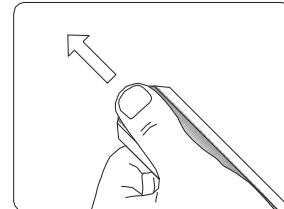

Grind until you can feel the burr along the entire edge.

### Honing

If you don't do the final sharpening on a Tormek water cooled grinder, then remove the burr and refine the edge with a honing stone.hone the flute with a slip stone. A finer edge cuts more cleanly, leaves a finer surface on the wood and stays sharp longer.



## Parting, Beading and Bedan Tools

The Multi Jig SVS-50 with the open seat is used



### Settings

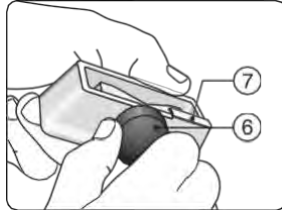

Lock the seat with the bottom screw (6) in the straight position (0°). The seat should touch the stop (7).

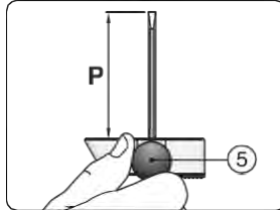

Mount the tool protruding (P) 65 mm (2 3/4") and lock it with the top screw (5).

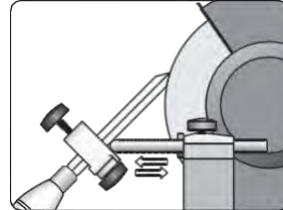

Set the edge angle by adjusting the Universal Support.

When re-sharpening an existing edge angle, use the Marker Method or the Spacer Block Method (page 26).

### Sharpening

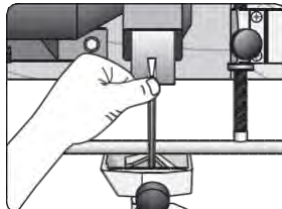

Hold the tool vertically on the Universal Support.

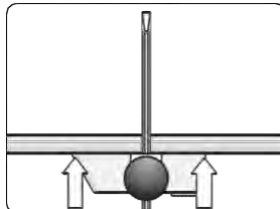

Ensure that the entire flange of the jig is in contact with the Universal Support

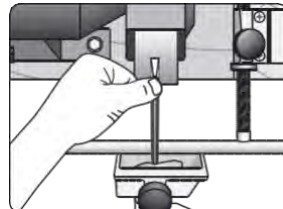

When the first side is ground then turn the tool around 180° and grind the other side.

## Sharpening Scrapers

These are sharpened with the Tool Rest SVD-110. Scrapers are available in different shapes. You can also put a new shape on your scraper according to your own choice. They usually come from the manufacturers with an edge angle between 70° and 80°. Some turners prefer a smaller edge angle 65° or even down to 45°.

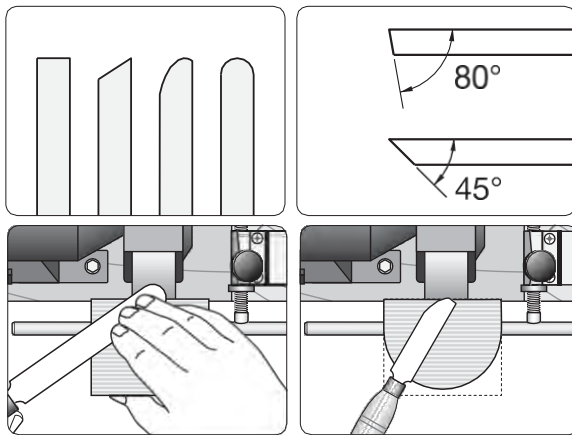

*The generous surface gives you a good support.*

*For shorter tools you can trim the surface to suit the tool.*

When sharpening there will be a build up of metal on top of the edge which is the burr. Unlike other turning tools the burr on scrapers is usually kept and not honed away. As an alternative you can remove the burr and instead create a burr like "micro hook" by burnishing (page 35).

The burr or micro hook causes the tool to cut the wood instead of scraping it as it would do without the burr.

The burr consists of a sintered (almost melted) mixture of steel waste and abrasives from the grinding wheel as well as solid steel which has been pushed upwards by the grinding wheel. The sintered mixture is not durable and will therefore decrease and wear away during the turning. How fast it wears depends on how heavy it is, which depends on how hard you have pushed the tool during the grinding. You need to regrind frequently to make new burrs.

Due to the way the burr is created, its quality, strength and life changes from one sharpening to another and the way it cuts the wood is not always predictable. The size of the edge angle also influences the shape of the burr and the way it works.

### Burnishing the edge

There is an alternative method to make a scraper work as a cutting tool. If you press with a hard steel rod towards the bevel at an angle ( $s$ ) of approx.  $5^\circ$ , the tip will be bent upwards creating a micro-hook. The pressure from the rod compresses the steel, smooths the small scratches left by the grindstone and makes the hook shiny.

The result is an even, sharp and durable micro-hook or cutting edge. The method is called *burnishing* and gives you a consistent and more durable hook than a burr. Before using the burnishing method, you should grind the bevel as evenly and finely as possible and hone the bevel as well as the top face to get a sharper and more durable cutting edge.

There are special burnishing tools available. You can also do the burnishing by using a 12 mm ( $\frac{1}{2}$ " ) bowl gouge. Clamp the scraper in your workbench vice so you can hold the burnishing tool steadily with both hands.

You must not burnish too heavily so that the hook is bent backwards. The tip of the hook must point upwards to work. You should also adjust the pressure according to the edge angle. A scraper with a large edge angle ( $70-80^\circ$ ) requires a larger pressure than one with a smaller edge angle.

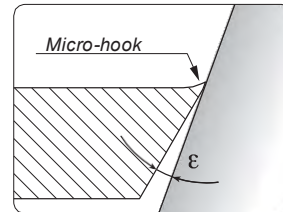

*Burnishing the edge. The tip of the edge is pressed upwards forming a small edge hook. (Here enlarged for clarity)*

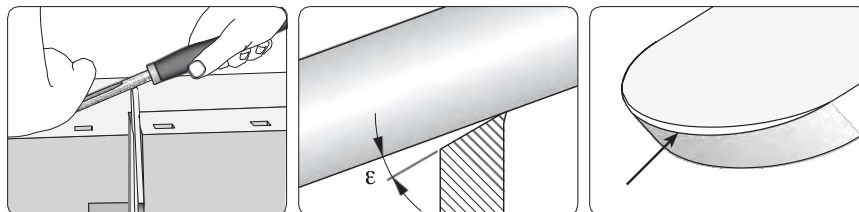

*Clamp the scraper in your workbench and support your left hand on the bench. Use a light pressure. Press the gouge on the bevel at an angle ( $c$ ) of approx.  $5^\circ$ . The hook is exaggerated for clarity. You will notice how the burnishing has compressed the tip of the edge to a smooth and shiny surface.*

The function of the scraper after burnishing depends on how large a hook you put on the edge. The size and shape of the hook depends on the edge angle of the scraper, the burnishing angle ( $s$ ) and how hard you press the burnishing tool.

## Sharpening Thin and Flat Parting Tools

These are sharpened with the Tool Rest SVD-110

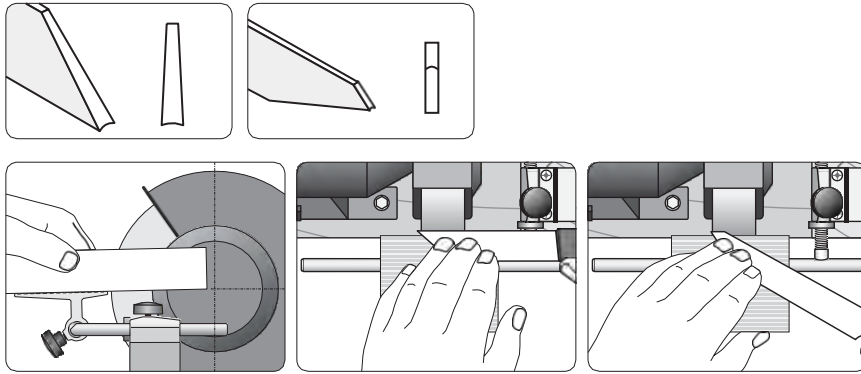

*Mark the centre of the wheel. Align and lock the Tool Rest so its surface points to the centre of the wheel. Use the Marker Method to ensure that you have the correct alignment before you commence grinding.*

## Sharpening Elliptical Spindle Tools

These are sharpened in the Gouge Jig SVD-186

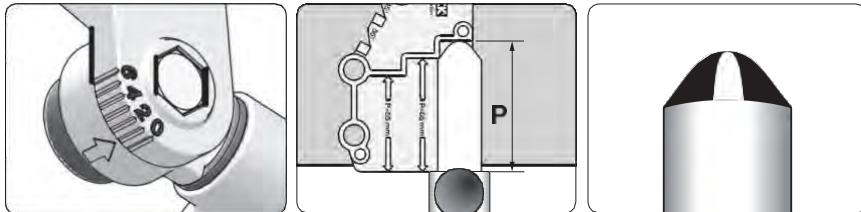

*On a common spindle tool, i.e. the Sorby Spindle Master, set the jig on No 1. Mount the tool with 75 mm (3") protrusion. Set the edge angle with the Marker Method (page 26).*

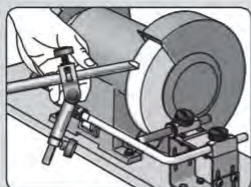

Gouge Jig SVD-186

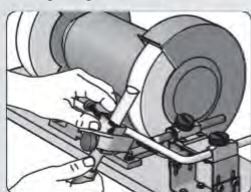

Multi Jig SVS-50

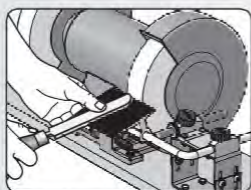

Tool Rest SVD-110

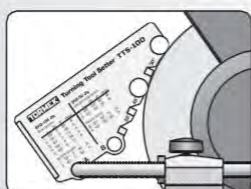

Turning Tool Setter TTS-100

With the mounting set BGM-100 you can now use the Tormek Jigs for woodturning tools (SVD-186, SVS-50, SVD-110) and the patented Turning Tool Setter TTS-100 also on your bench grinder!

This handbook shows you in detail how to shape and re-sharpen all your woodturning tools: bowl gouges, spindle gouges, skewers, scrapers and parting tools. You also get instructions on how to build the wooden platform to suit your grinder.

The Tormek method makes a distinction between shaping and sharpening. Once you have created the desired shape on the tool, the Turning Tool Setter TTS-100 makes it an easy task to re-sharpen the tool to exactly the same shape. This patented setting device takes the guesswork out of sharpening. There is no longer any need for trial and error to get the best edge shape for each turning operation. You just set the jig and get the shape you have selected. Thanks to the design it works irrespectively of the stone diameter.

This instruction is exclusively for HSS turning tools, since dry grinding at high speed is not suitable for ordinary carbon steel tools due to the risk of overheating and the aggressive steel removal.

**TORMEK**  
Sharpening Innovation